

ASSEMBLY INSTRUCTION

3107-CP1706-DK-GRIS-1864















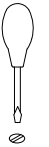
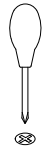
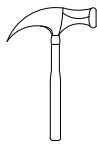

- | | | | | | | | | | | | |
|--|--|--|---|--|--|---|---|--|---|---|---|
| 
A x4
Spec: Ø8*30 | 
B x4
Spec: Ø7*1,30 | 
C x4
Spec: Ø15*H12 | 
D x14
Spec: M6*25 | 
E x6
Spec: M6*15 | 
F x12
Spec: M18*8, 2 | 
G x8
Spec: M14*8, 2 |  |  |  |  |  |
| 
H x1
Spec: | 
I x6
Spec: 38*38 | 
J x4
Spec: 20*20 | 
K x1
Spec: 10g | 
L x1
Spec: | | | | | | | |

FIG. 1

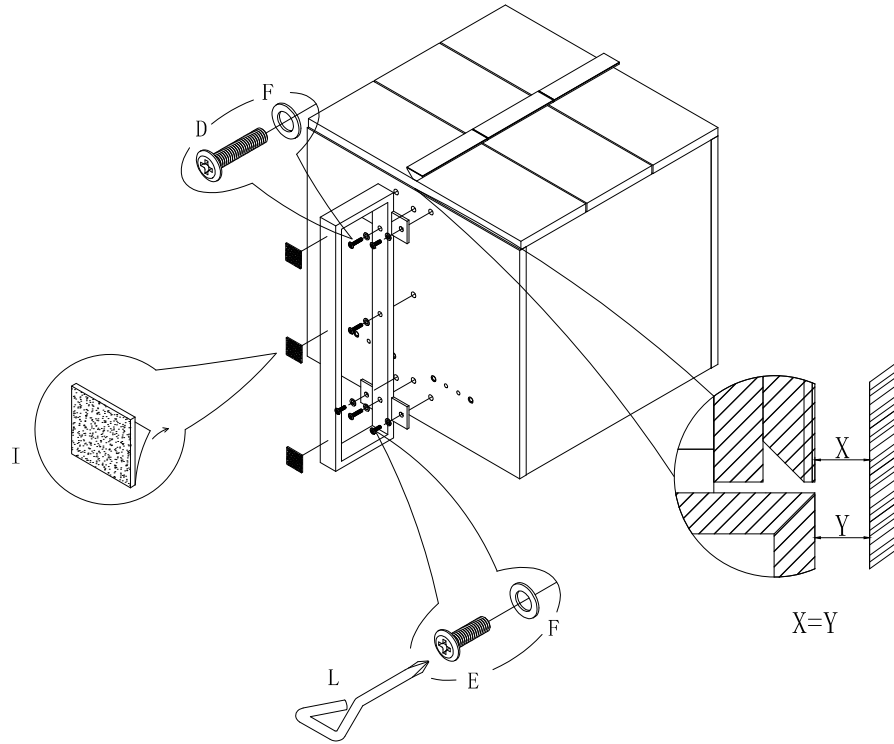

FIG. 2

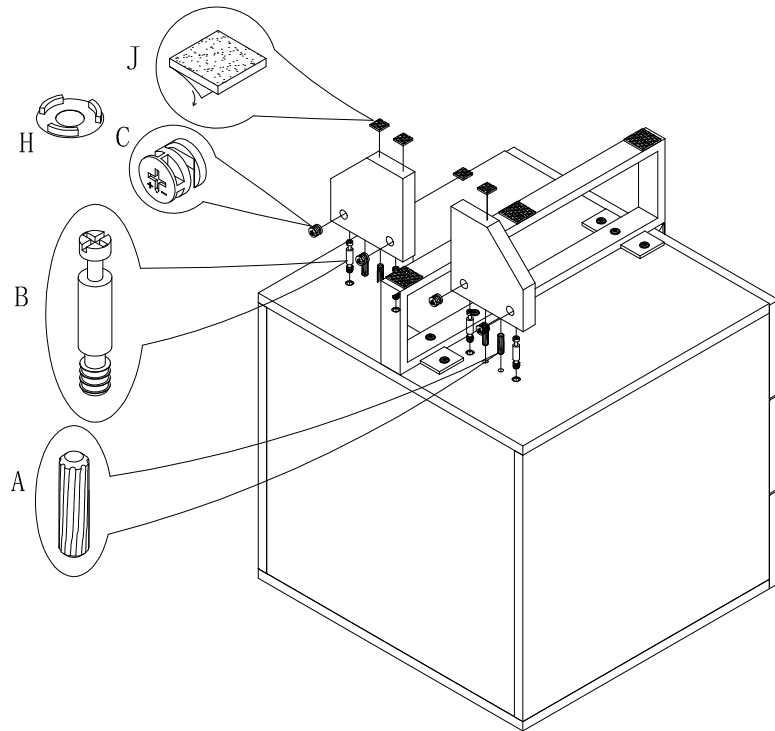

FIG.
3

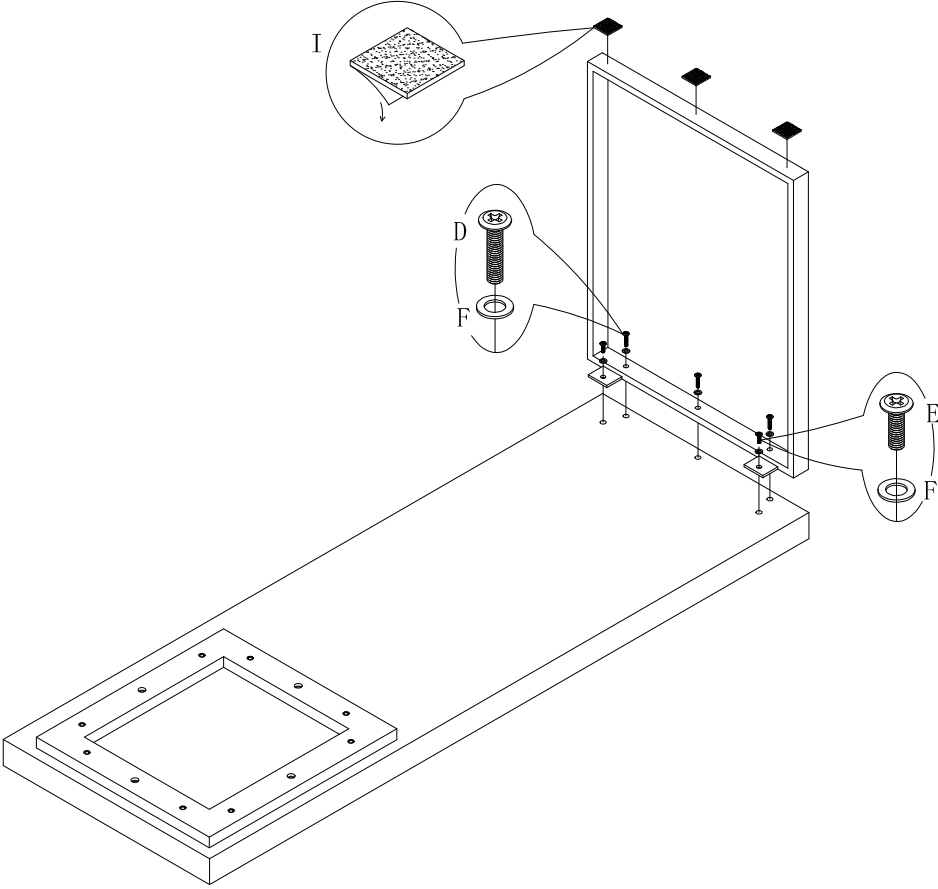

FIG.
4

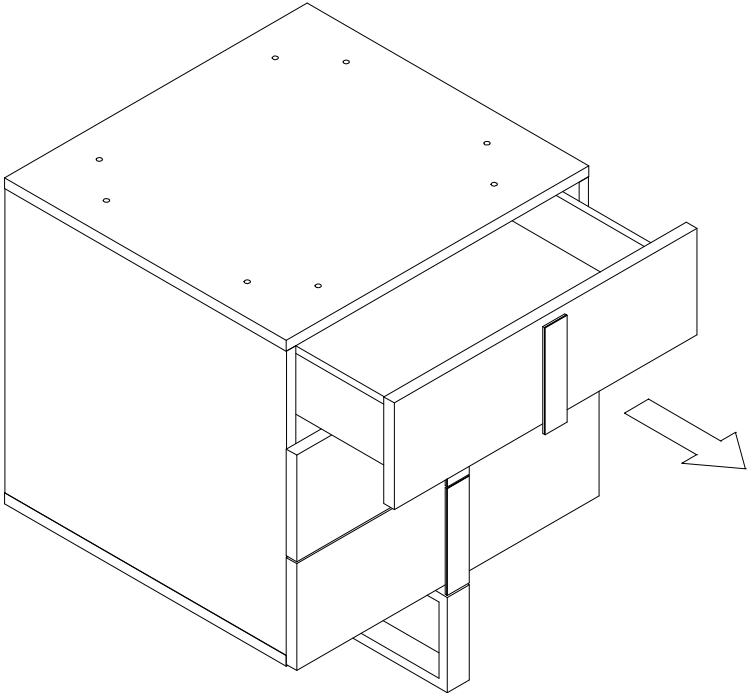

FIG.
5

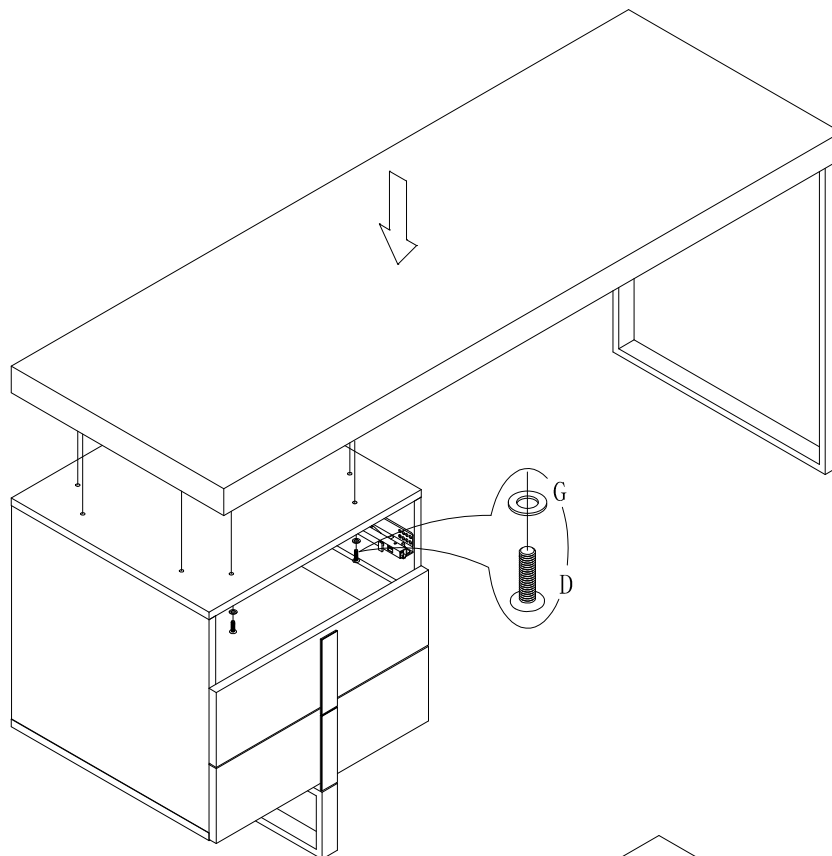

FIG.
6

