



1PC



1PC

FIG.
1

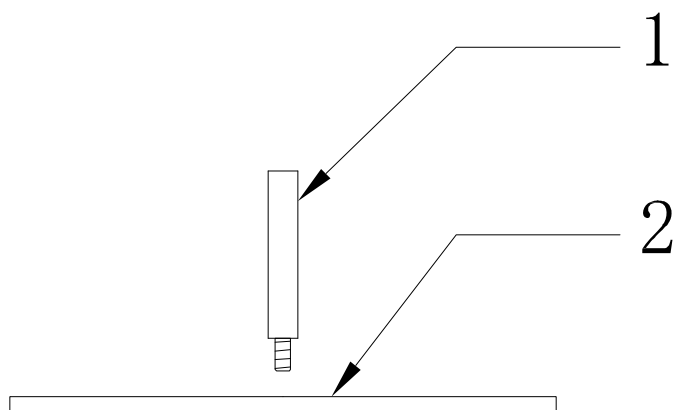

Fit part 1 to base n°2

FIG.
3

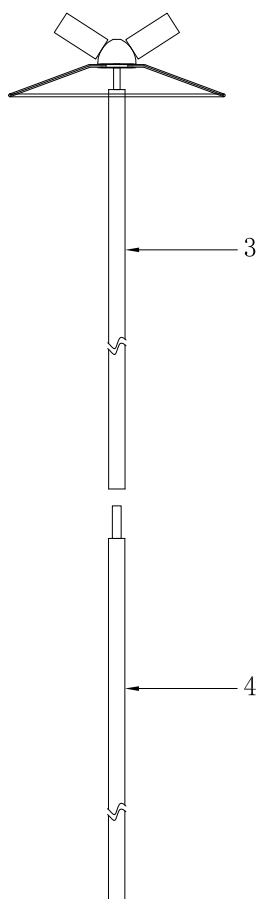

Fit part 3 to part n°4



1PC



1PC

FIG.
3

