

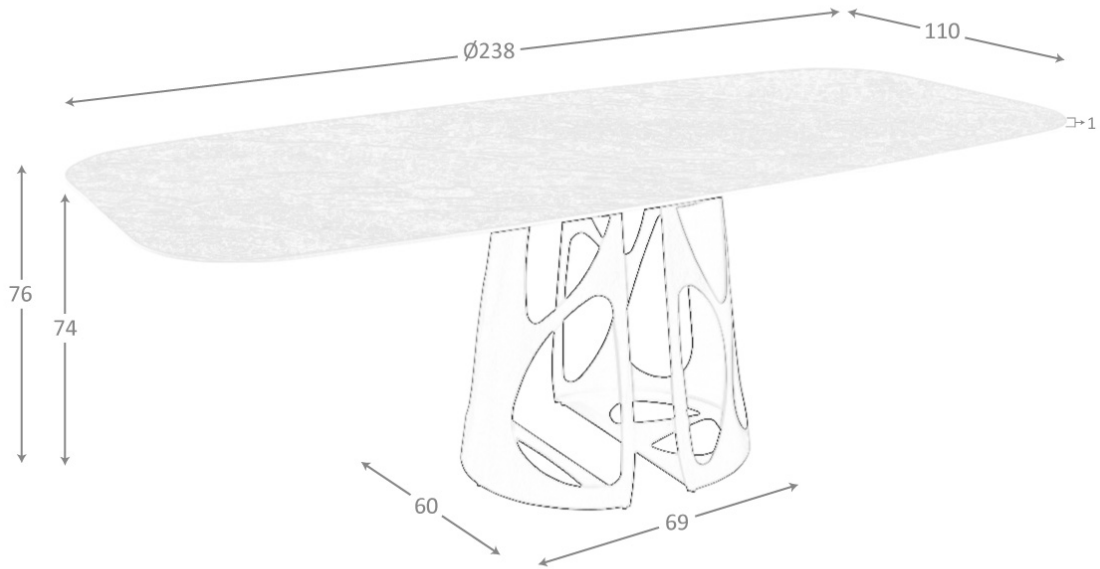

1136

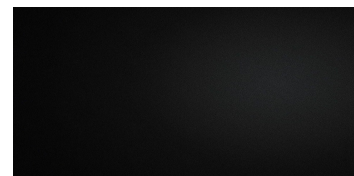

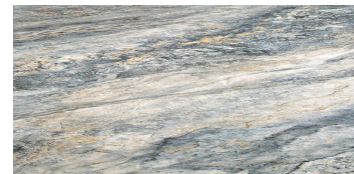

$\varnothing 238 \times 110 \times 76$ cm
137 Kg
0,60 m³





 242 x 115 x 6 cm

 92 Kg

 156 x 65 x 8 cm

 10 Kg

 65 x 65 x 74 cm

 41 Kg