









A	B	C	D	E	F	G	H
			 M8*10	 M8*15	 Ø17*Ø8*1	 P8	 P5
1 PC	4 PCS	4 PCS	6 PCS	4 PCS	10PCS	1 PC	1 PC







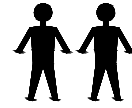
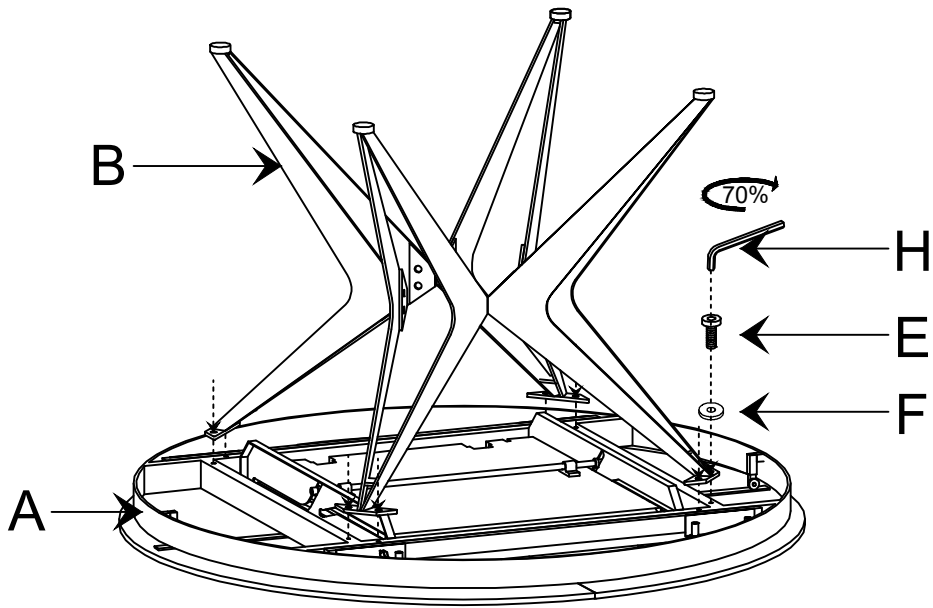

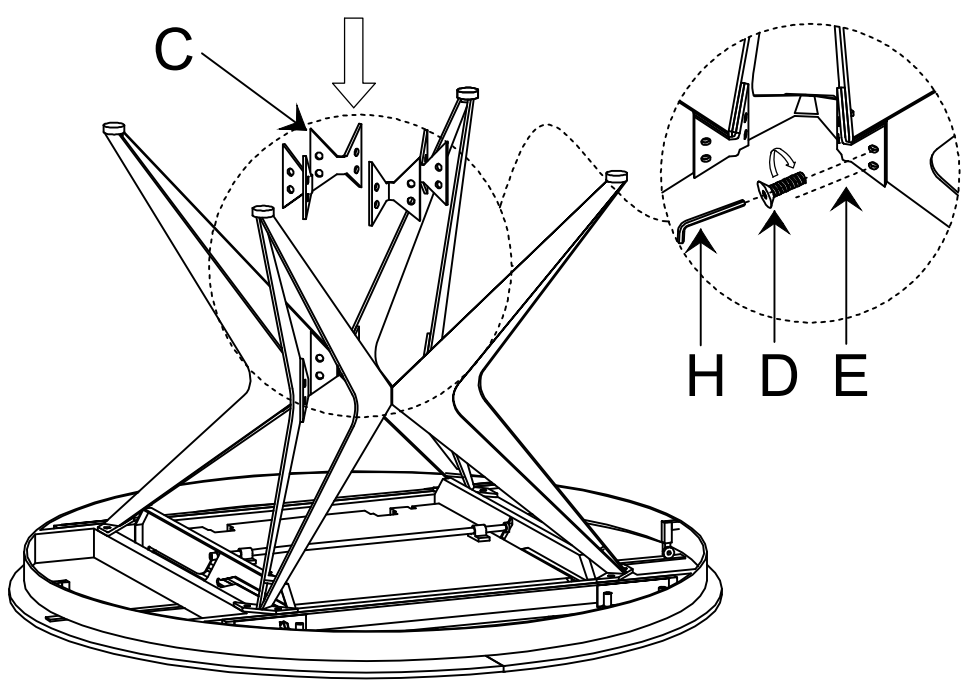

**FIG.**  
**1**



**FIG.**  
**2**



A	B	C	D	E	F	G	H
			 M8*10	 M8*15	 Ø17*Ø8*1	 P8	 P5
1 PC	4 PCS	4 PCS	6 PCS	4 PCS	10PCS	1 PC	1 PC





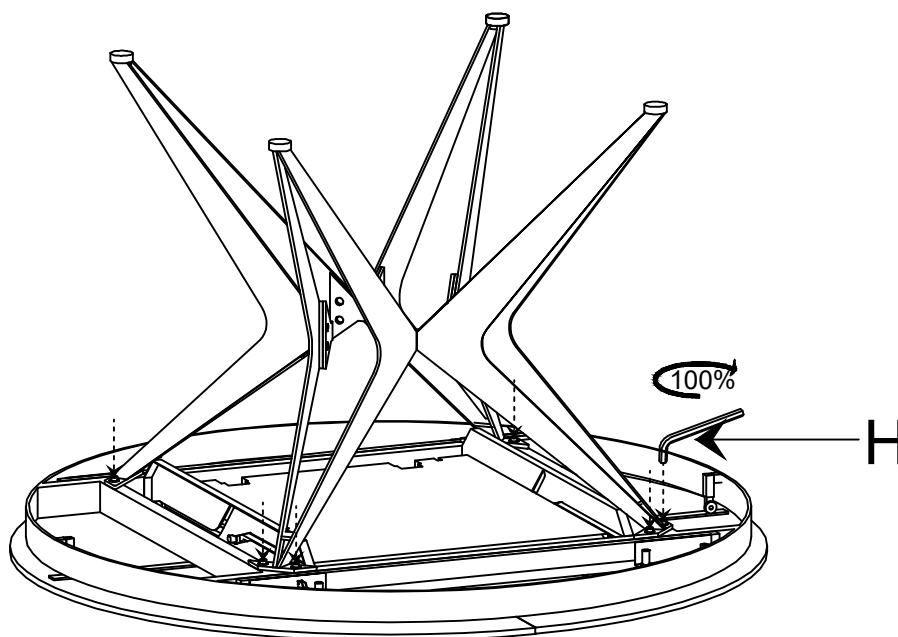



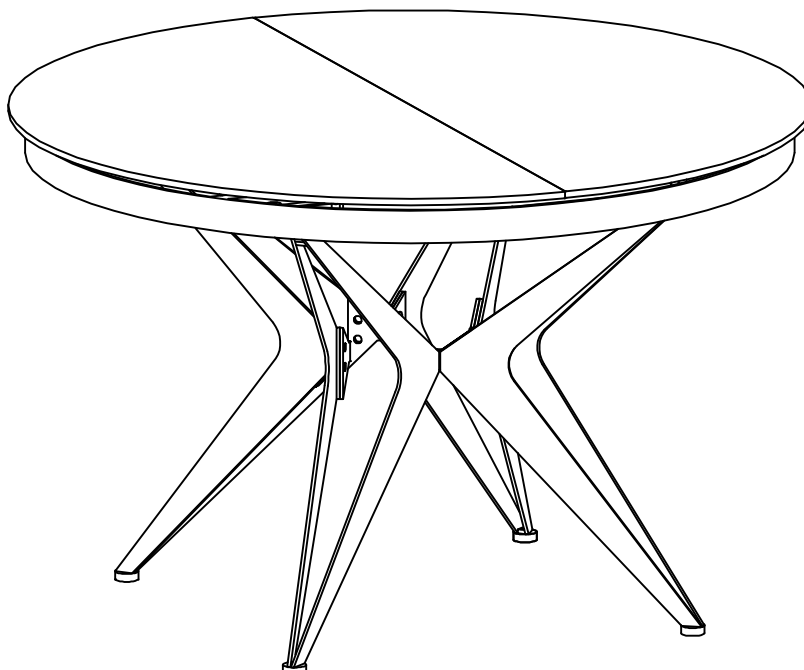

**FIG.**  
**3**



**FIG.**  
**4**



A	B	C	D	E	F	G	H
			 M8*10	 M8*15	 Ø17*Ø8*1	 P8	 P5
1 PC	4 PCS	4 PCS	6 PCS	4 PCS	10PCS	1 PC	1 PC

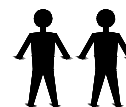







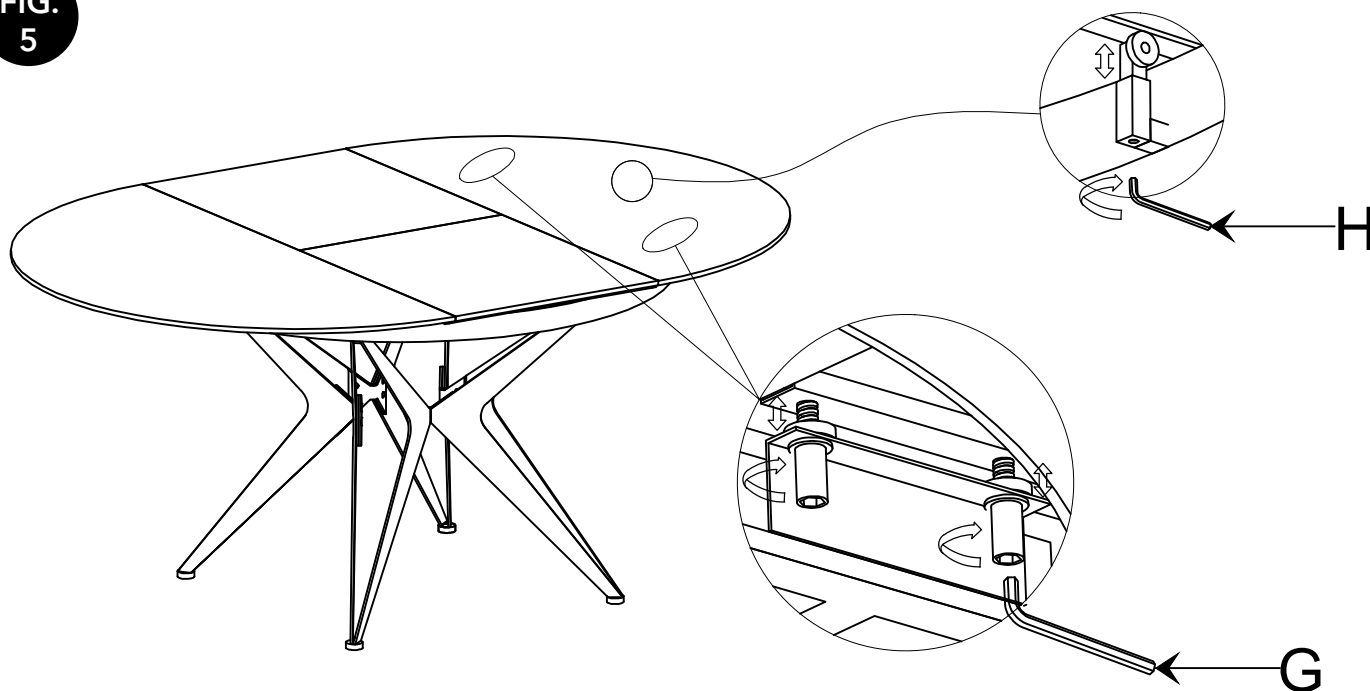

## ADJUSTMENTS

**FIG.**  
**4**



**FIG.**  
**5**



A	B	C	D	E	F	G	H
			 M8*10	 M8*15	 Ø17*Ø8*1	 P8	 P5
1 PC	4 PCS	4 PCS	6 PCS	4 PCS	10PCS	1 PC	1 PC







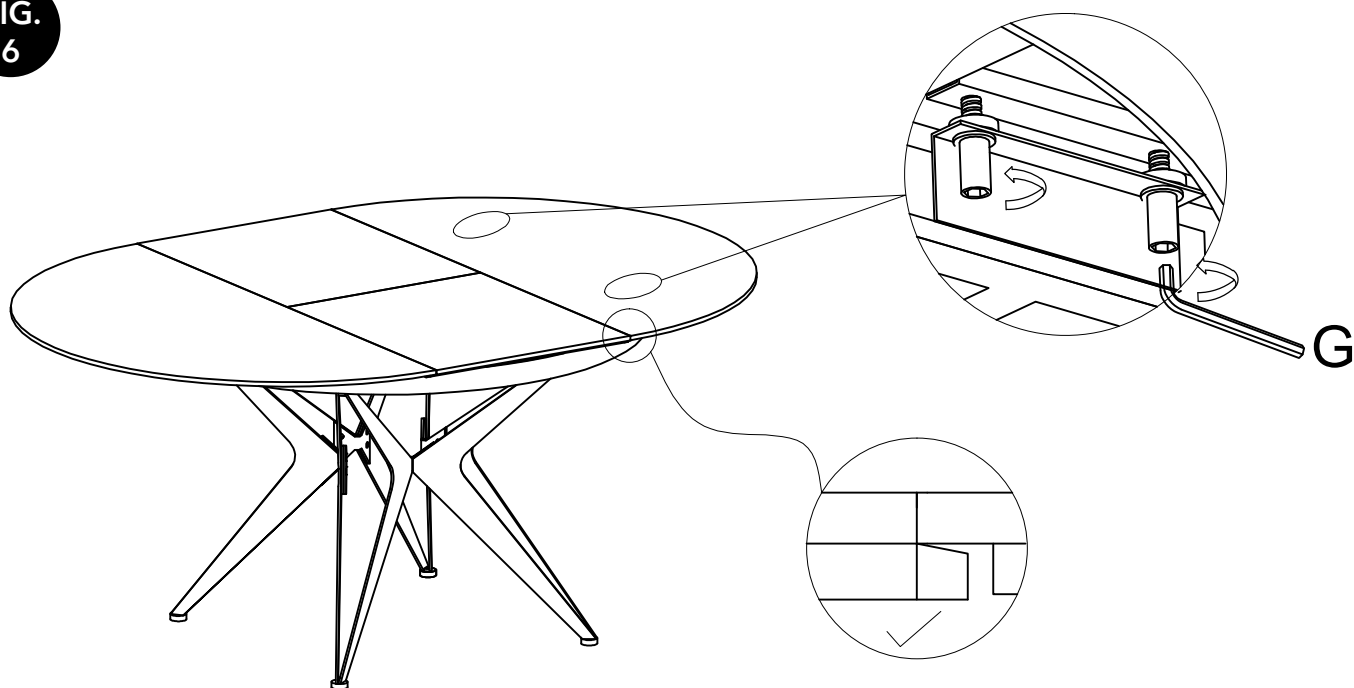

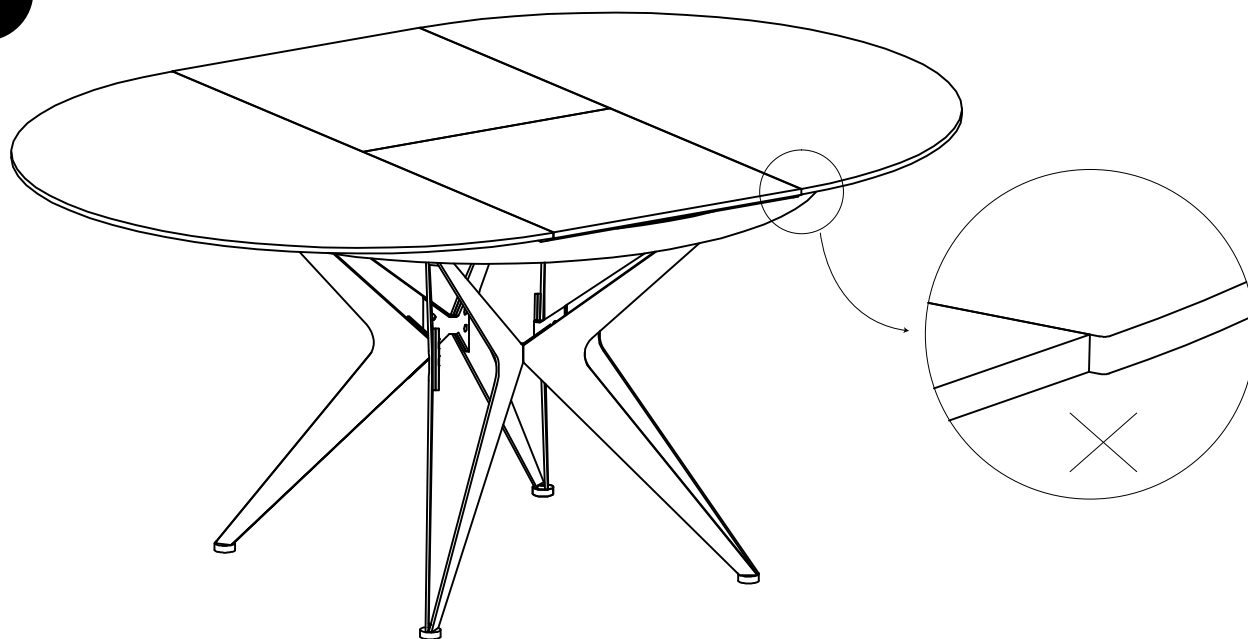

## ADJUSTMENTS

**FIG.**  
**6**



**FIG.**  
**7**



A	B	C	D	E	F	G	H
							
1 PC	4 PCS	4 PCS	6 PCS	4 PCS	10PCS	1 PC	1 PC



## ADJUSTMENTS

**FIG.**  
**8**



**FIG.**  
**9**

