









A	B	C	D	E	F	G	H	I
								
1 PC	1 PC	4 PCS	1 PC	12 PCS	4 PCS	8 PCS	1 PC	1 PC







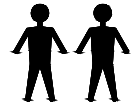
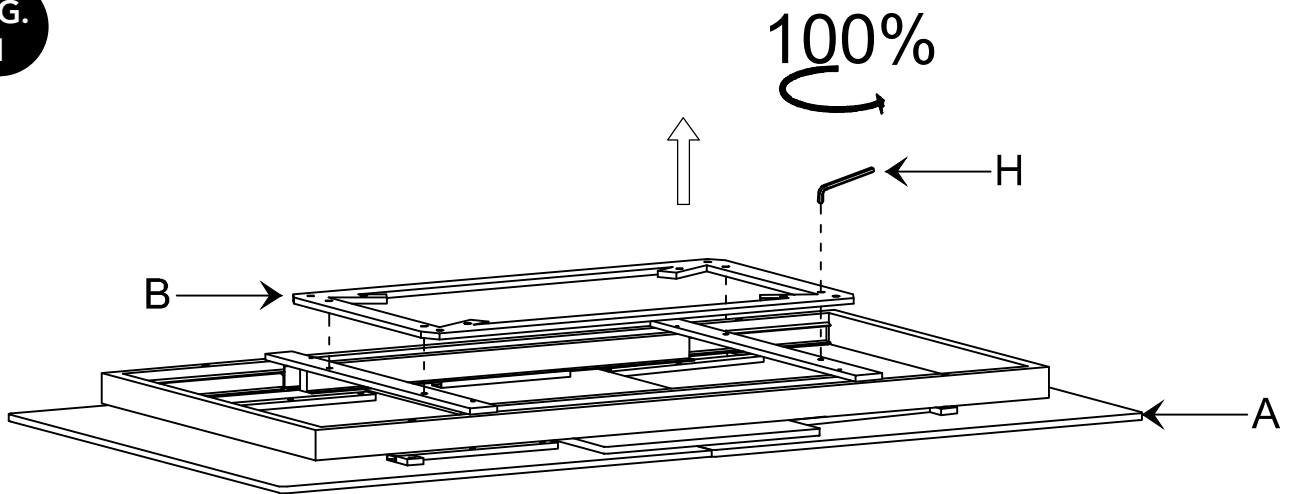

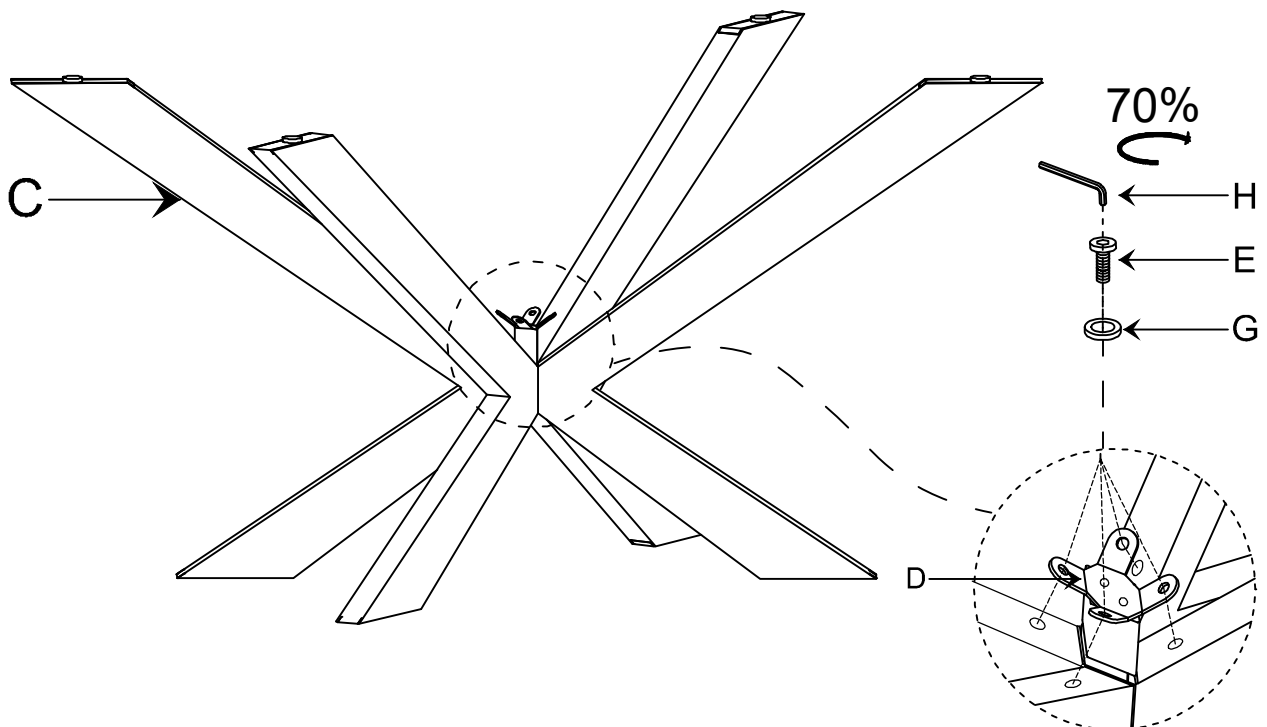

**FIG. 1**



**FIG. 2**



A	B	C	D	E	F	G	H	I
								
1 PC	1 PC	4 PCS	1 PC	12 PCS	4 PCS	8 PCS	1 PC	1 PC

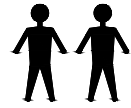



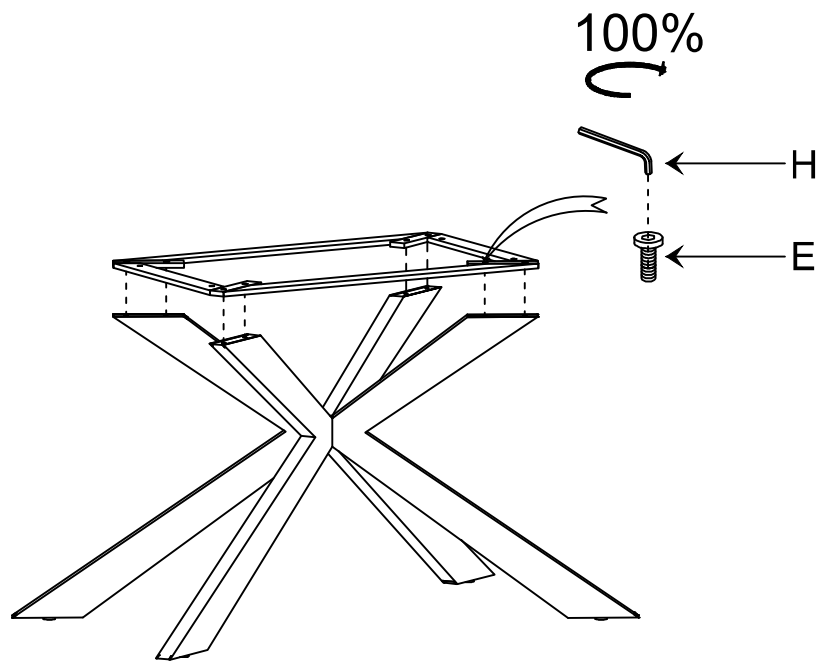



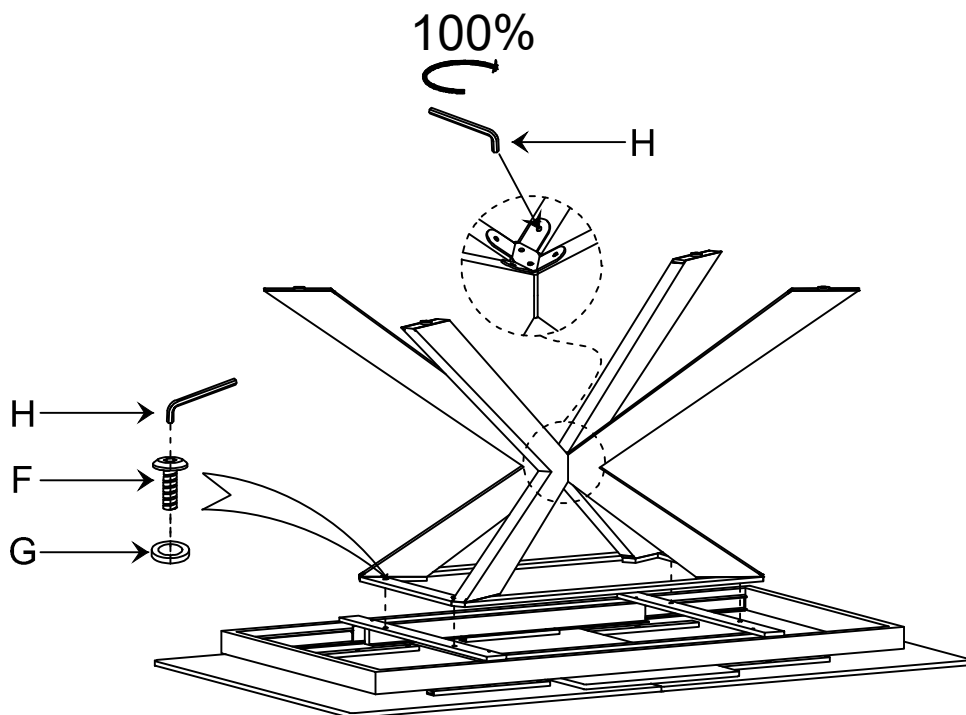

**FIG.**  
**3**



**FIG.**  
**4**



A	B	C	D	E	F	G	H	I
								
1 PC	1 PC	4 PCS	1 PC	12 PCS	4 PCS	8 PCS	1 PC	1 PC

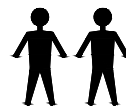

## ADJUSTMENT

**FIG.  
5**

Please remove the screws first before operating the function.

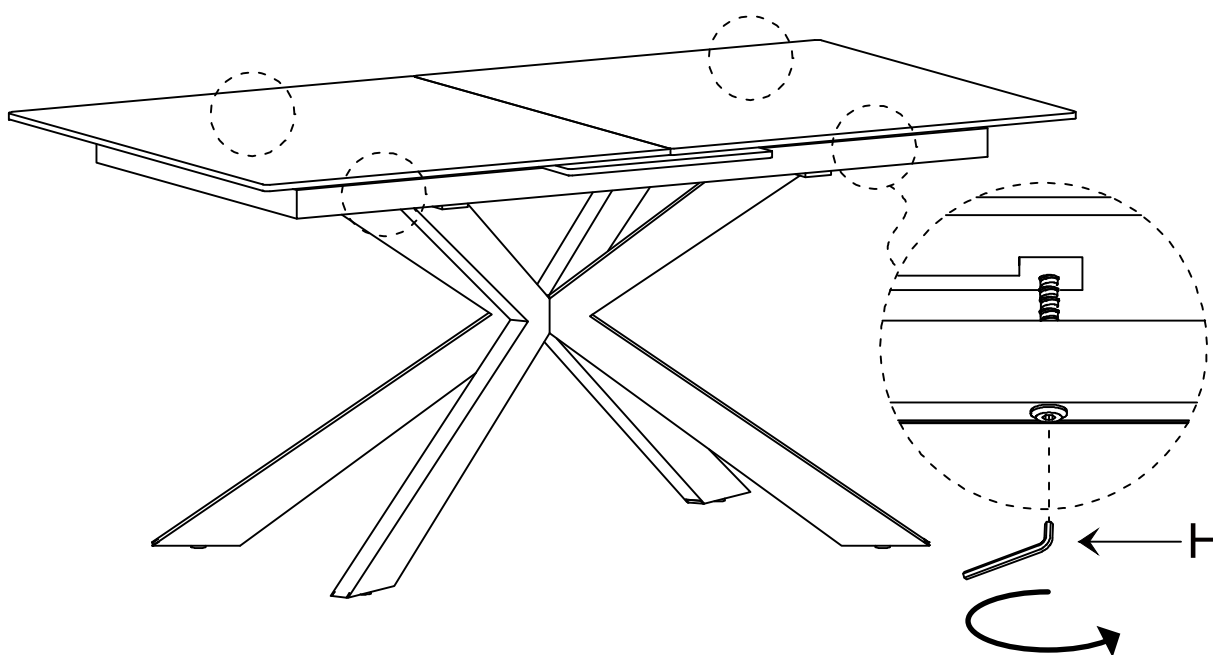

**FIG.  
6**

