













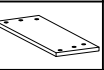

A	B	C	D	E	F	H	I
							
1 PC	4 PCS	2 PCS	2 PCS	1 PC	1 PC	4 PCS	4 PCS
J	K	L	M	N	O	P	
							
12 PCS	8 PCS	16 PCS	1 PC	1 PC	1 PC	1 PC	

FIG. 1

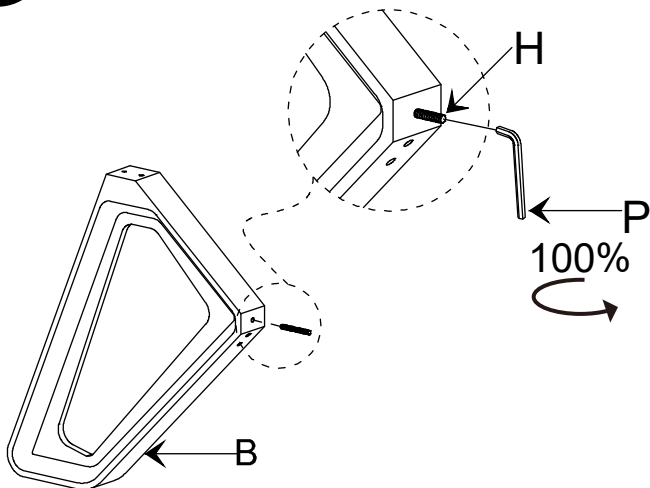

FIG. 2

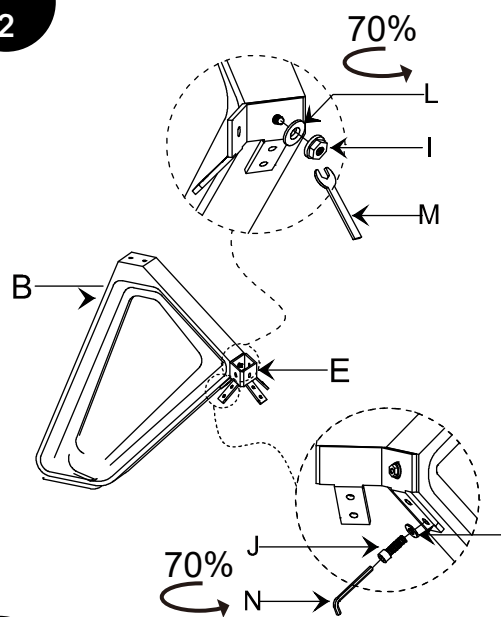

FIG. 3

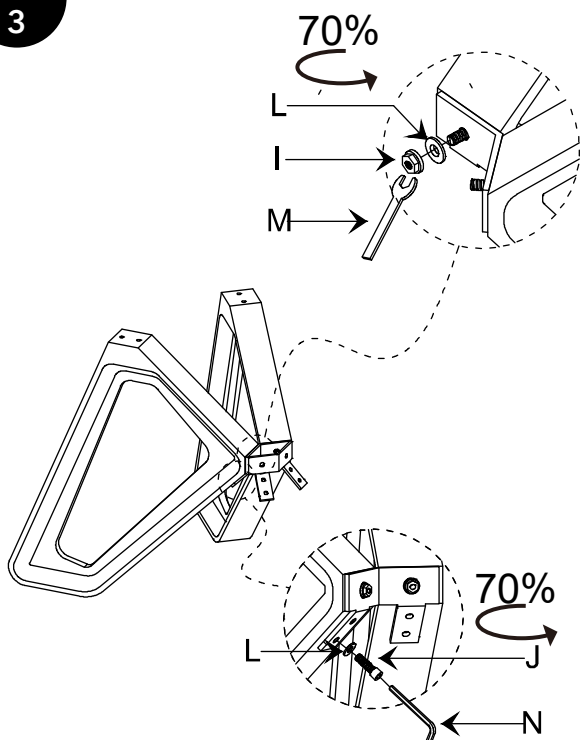
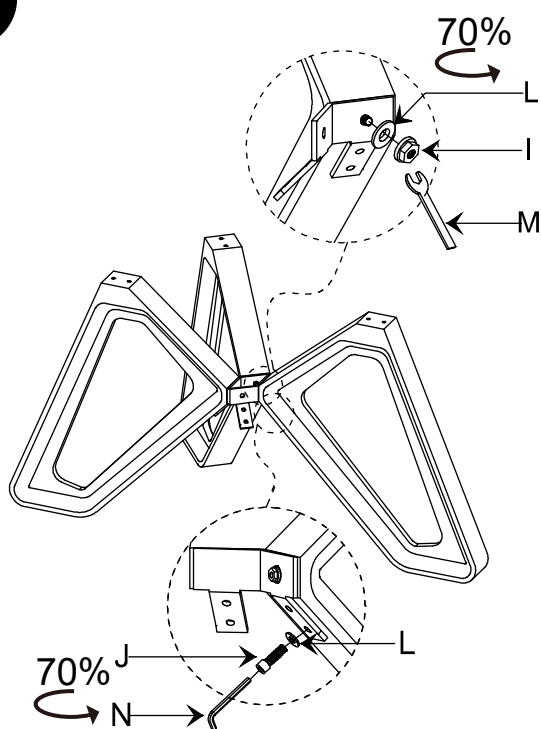

FIG. 4



















A	B	C	D	E	F	H	I
							
1 PC	4 PCS	2 PCS	2 PCS	1 PC	1 PC	4 PCS	4 PCS
J	K	L	M	N	O	P	
							
12 PCS	8 PCS	16 PCS	1 PC	1 PC	1 PC	1 PC	

FIG. 5

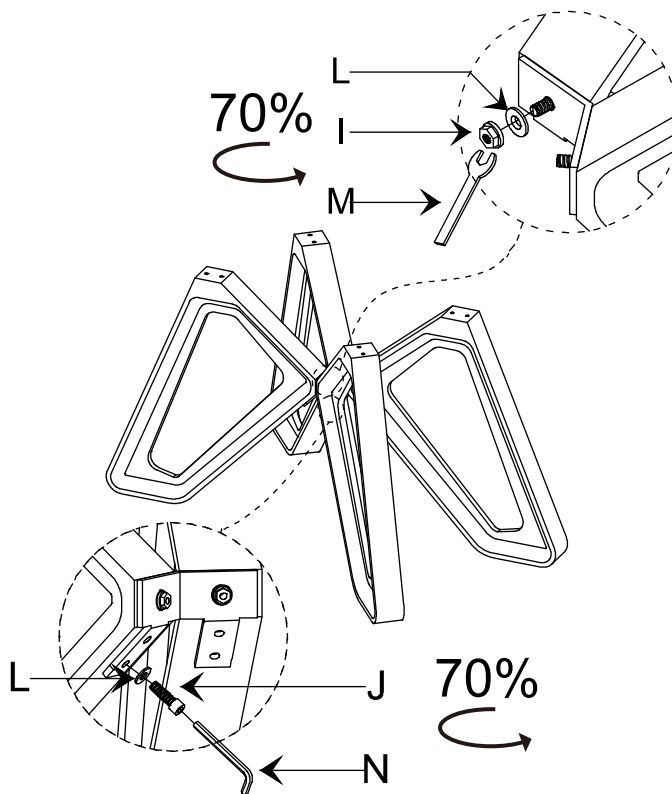
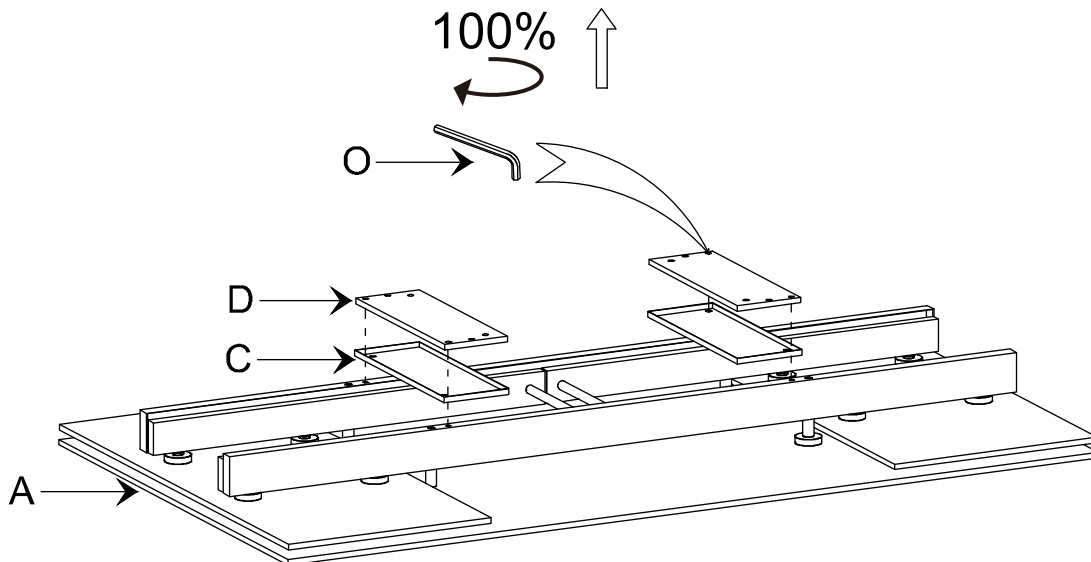

FIG. 6



















A	B	C	D	E	F	H	I
							
1 PC	4 PCS	2 PCS	2 PCS	1 PC	1 PC	4 PCS	4 PCS
J	K	L	M	N	O	P	
							
12 PCS	8 PCS	16 PCS	1 PC	1 PC	1 PC	1 PC	

FIG. 7

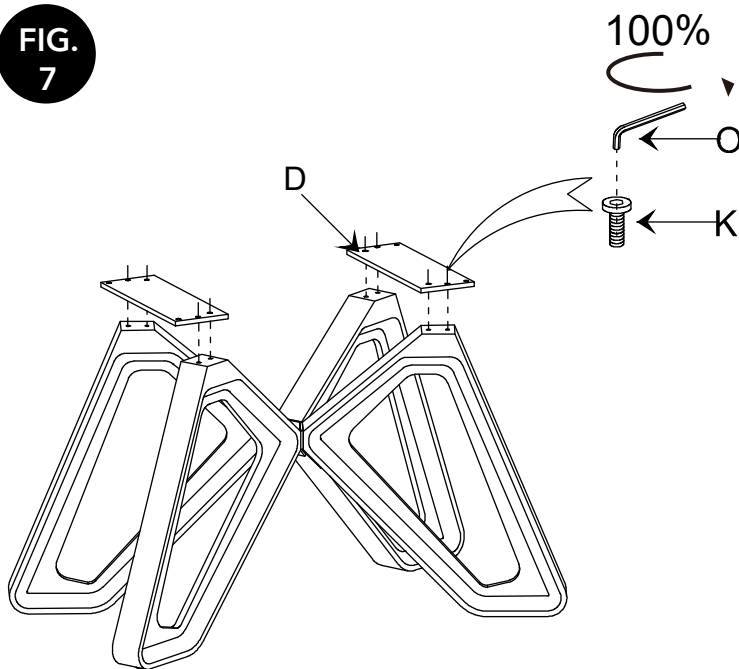

FIG. 8

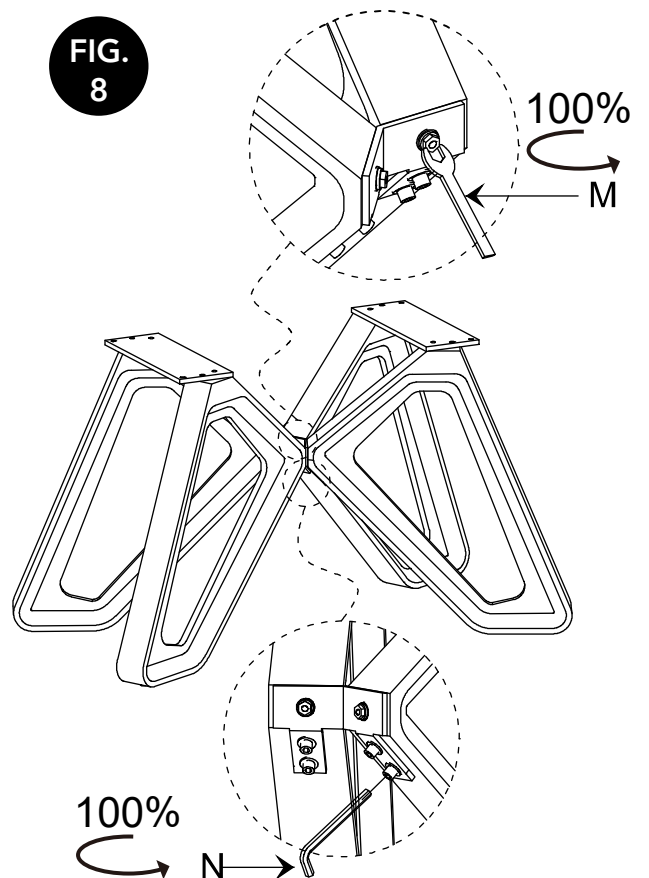
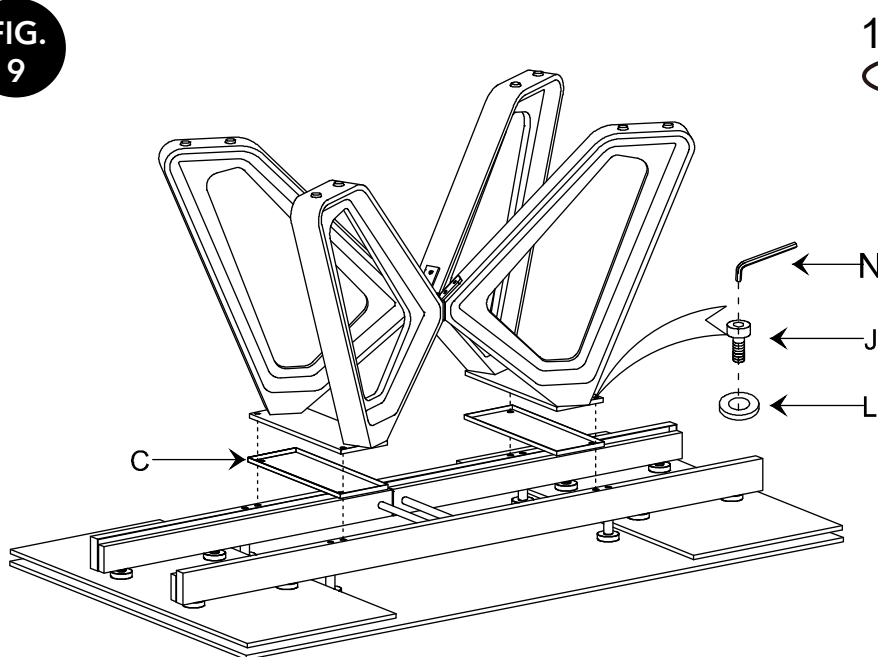

FIG. 9















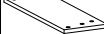

A	B	C	D	E	F	H	I
							
1 PC	4 PCS	2 PCS	2 PCS	1 PC	1 PC	4 PCS	4 PCS
J	K	L	M	N	O	P	
							
12 PCS	8 PCS	16 PCS	1 PC	1 PC	1 PC	1 PC	

FIG.
11

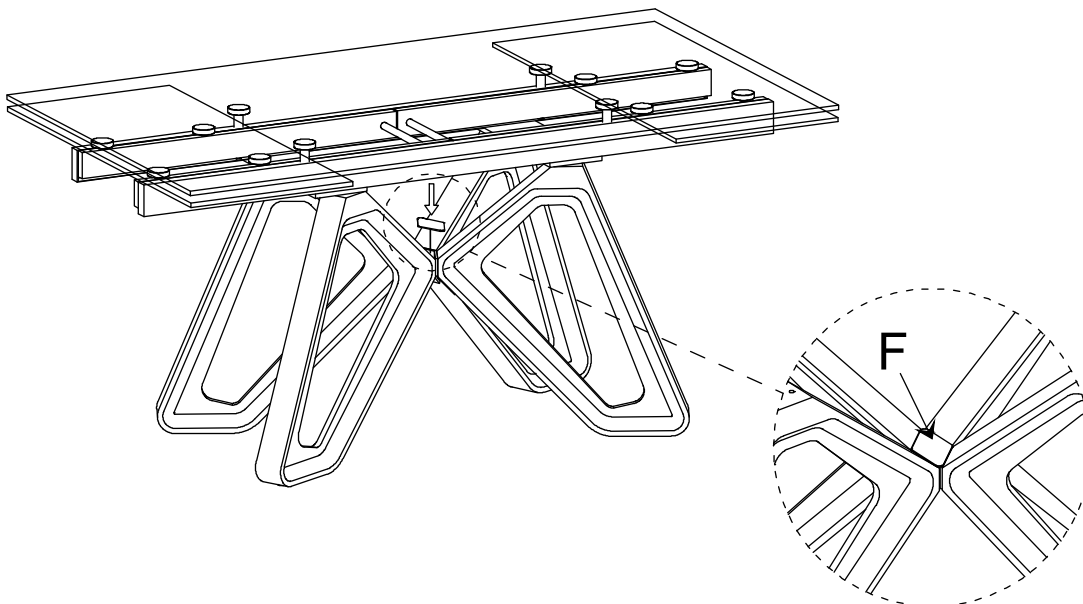
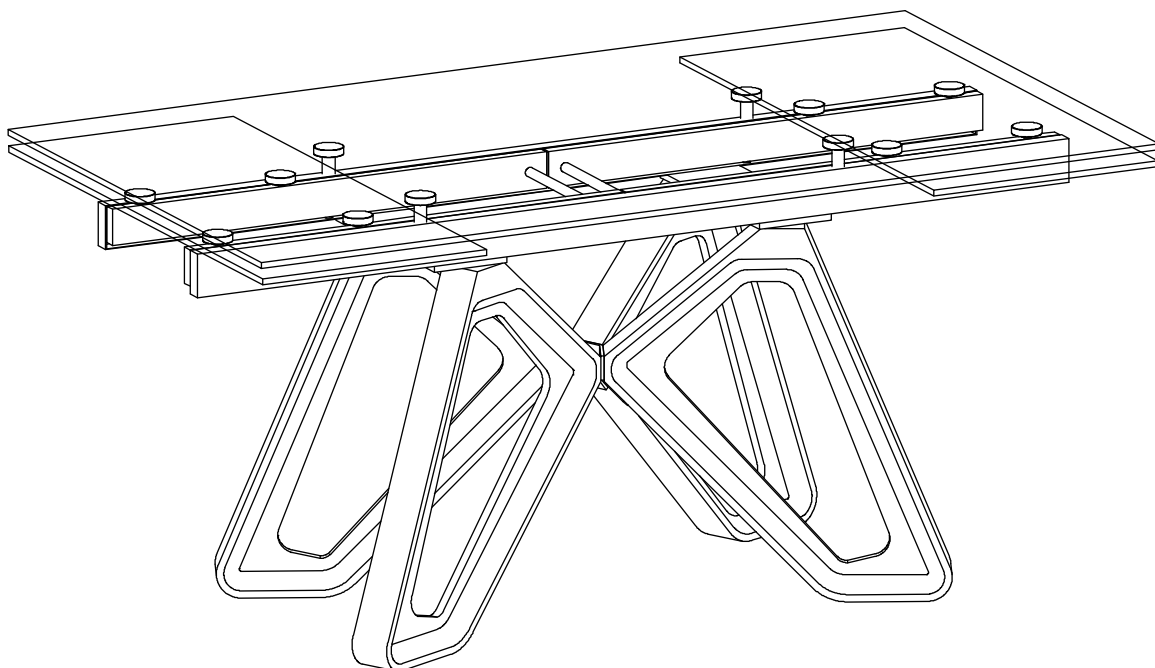

















FIG.
12



A	B	C	D	E	F	H	I
							
1 PC	4 PCS	2 PCS	2 PCS	1 PC	1 PC	4 PCS	4 PCS
J	K	L	M	N	O	P	
							
12 PCS	8 PCS	16 PCS	1 PC	1 PC	1 PC	1 PC	

ADJUSTMENT

FIG. 13

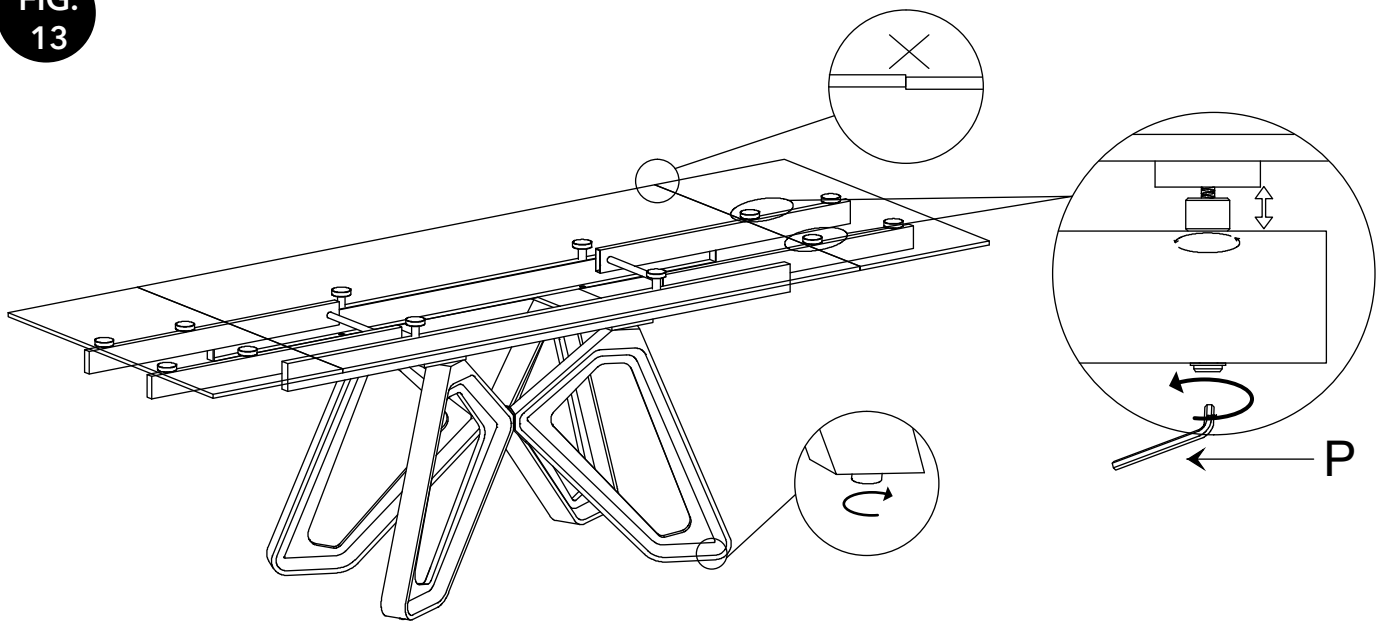
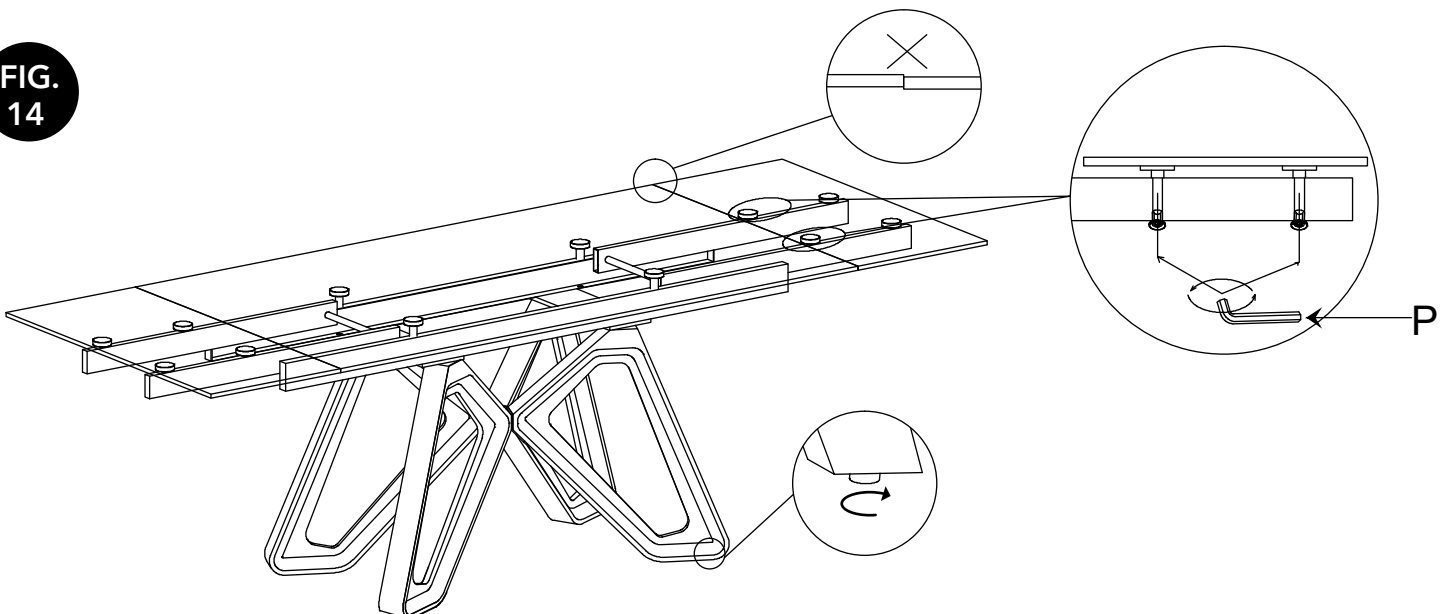

















FIG. 14



A	B	C	D	E	F	H	I
							
1 PC	4 PCS	2 PCS	2 PCS	1 PC	1 PC	4 PCS	4 PCS
J	K	L	M	N	O	P	
							
12 PCS	8 PCS	16 PCS	1 PC	1 PC	1 PC	1 PC	

ADJUSTMENT

FIG.
15

