





A	B	C	D
		 m8*10	 P5
1 PC	2 PCS	4 PCS	1 PC

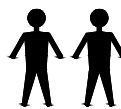

FIG.
1

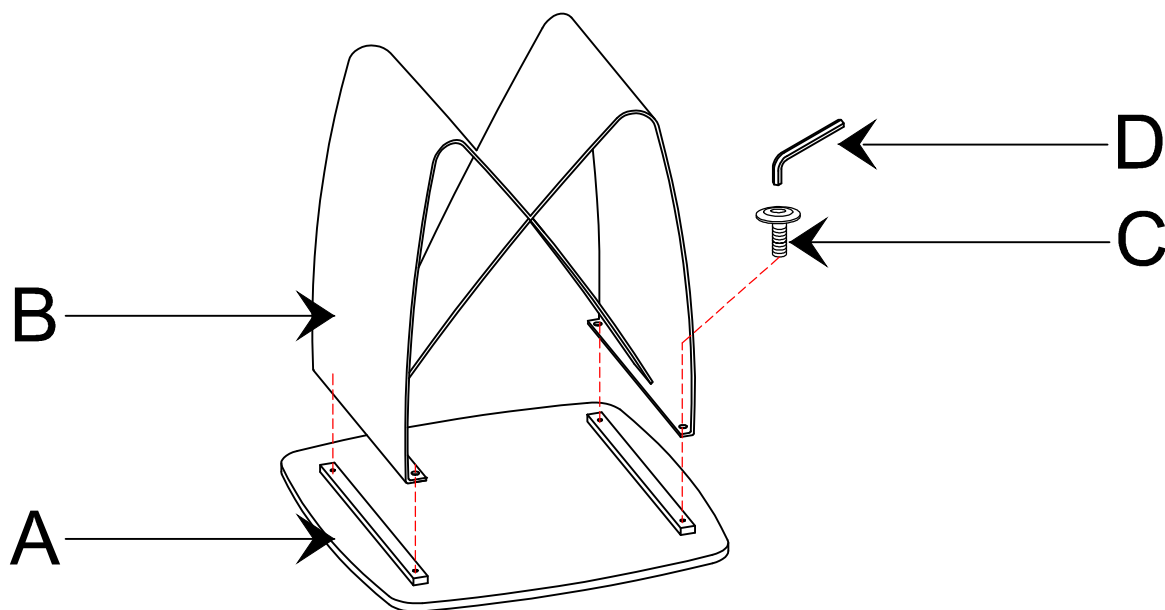
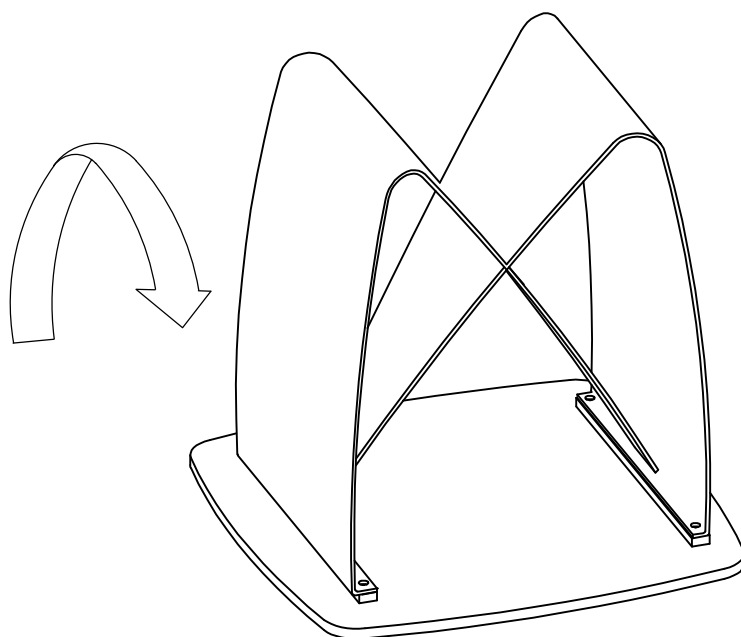





FIG.
2



A	B	C	D
		 m8*10	 P5
1 PC	2 PCS	4 PCS	1 PC

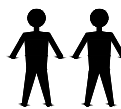

FIG.
3

