









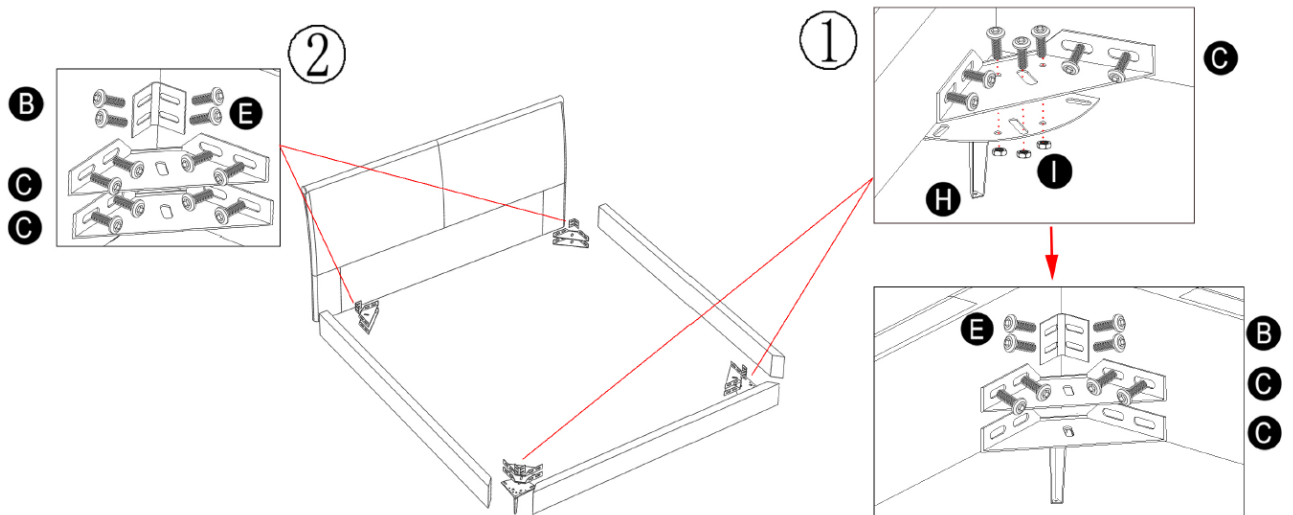
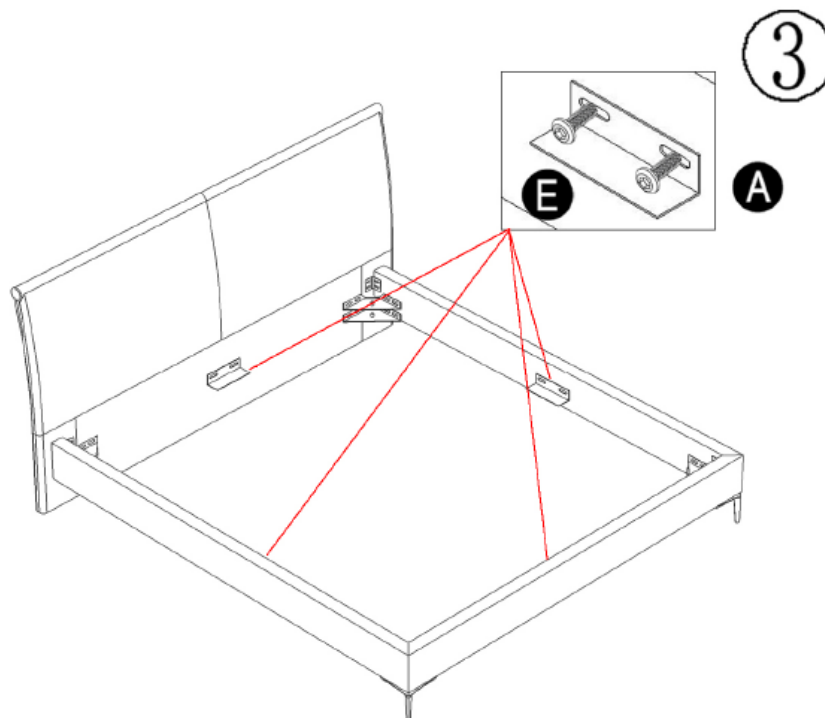




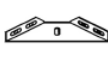




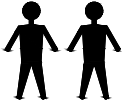


A	B	C	D	E	F	H
						
4 PCS	4 PCS	8 PCS	6 PCS	56 PCS	3 PCS	2 PCS
I	K					
						
4 PCS	1 PC					

**FIG. 1,2**

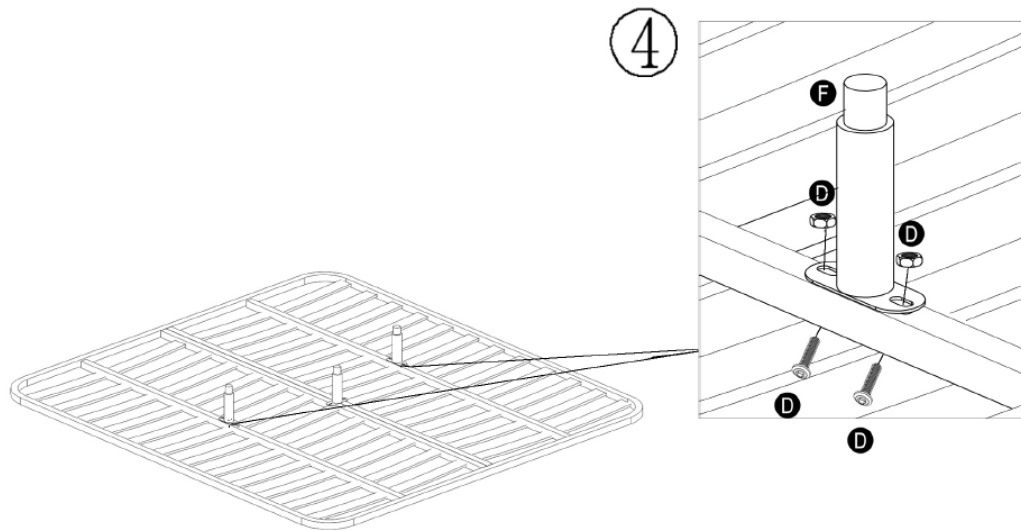


**FIG. 3**

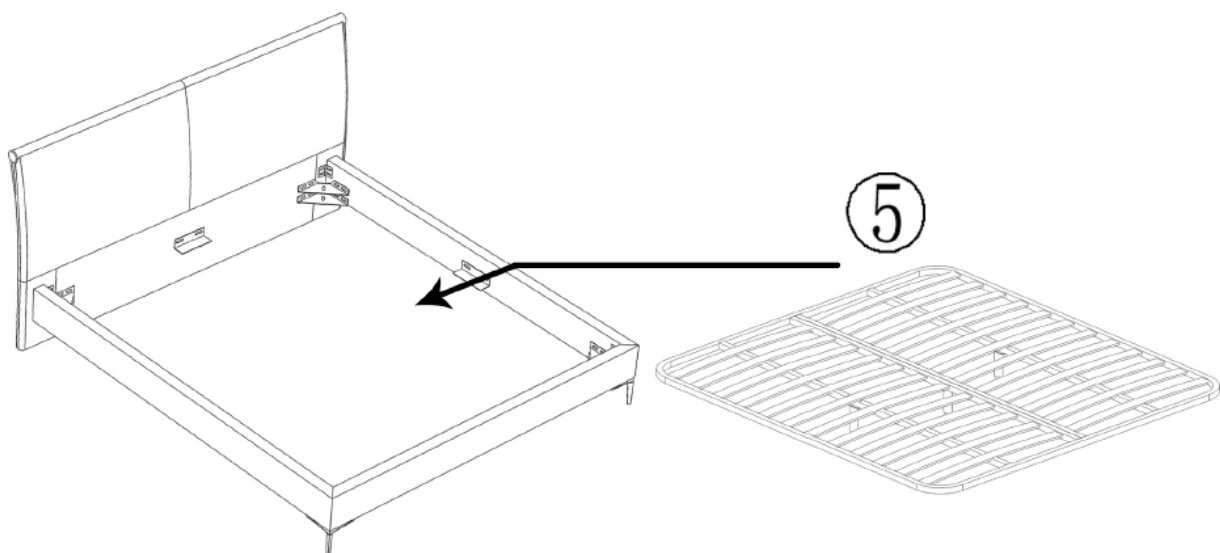




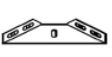




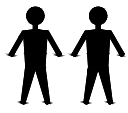


A	B	C	D	E	F	H
						
4 PCS	4 PCS	8 PCS	6 PCS	56 PCS	3 PCS	2 PCS
I	K					
						
4 PCS	1 PC					

**FIG.**  
**4**



**FIG.**  
**5**



A	B	C	D	E	F	H
			 8*50mm	 8*25mm		
4 PCS	4 PCS	8 PCS	6 PCS	56 PCS	3 PCS	2 PCS
I	K					
 8*25mm						
4 PCS	1 PC					

**FIG.**  
**6**

