





















ASSEMBLY INSTRUCTION

7178-C P1506-B-160-2456



- | | | | | | | |
|--|---|---|---|--|--|---|
| 
A x20
Spec: $\phi 8 \times 40$ | 
B x4
Spec: M8*L85 | 
C x4
Spec: | 
D x12
Spec: M8 | 
E x4
Spec: $\phi 38$ | 
F x1
Spec: 14# | 
G x32
Spec: $\phi 8 \times \phi 18$ |
| 
H x4
Spec: 5/16*L60 | 
I x1
Spec: 5# | 
J X1
Spec: 10g | 
K x12
Spec: $\phi 8 \times \phi 14$ | 
L x8
Spec: M8*L55 | 
M x12
Spec: M6*L15 | 
N x4
Spec: |
| 
O x16
Spec: M6*L45 | 
P x2
Spec: L240 | 
Q x2
Spec: 5/16*L60 | 
R x2
Spec: 5/16*L30 | 
S x4
Spec: 5/16*H18 | 
T x2
Spec: $\phi 3.8 \times L18$ | |

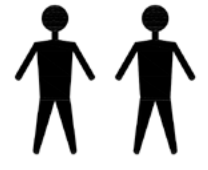
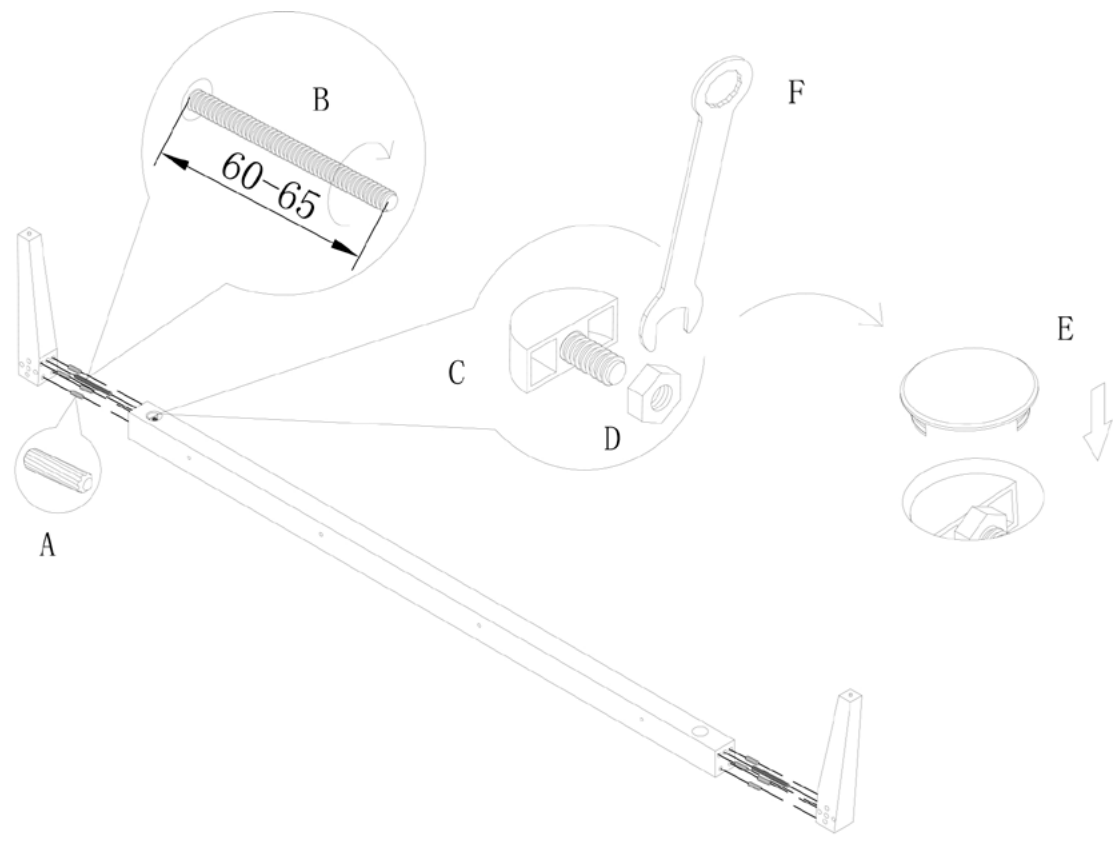
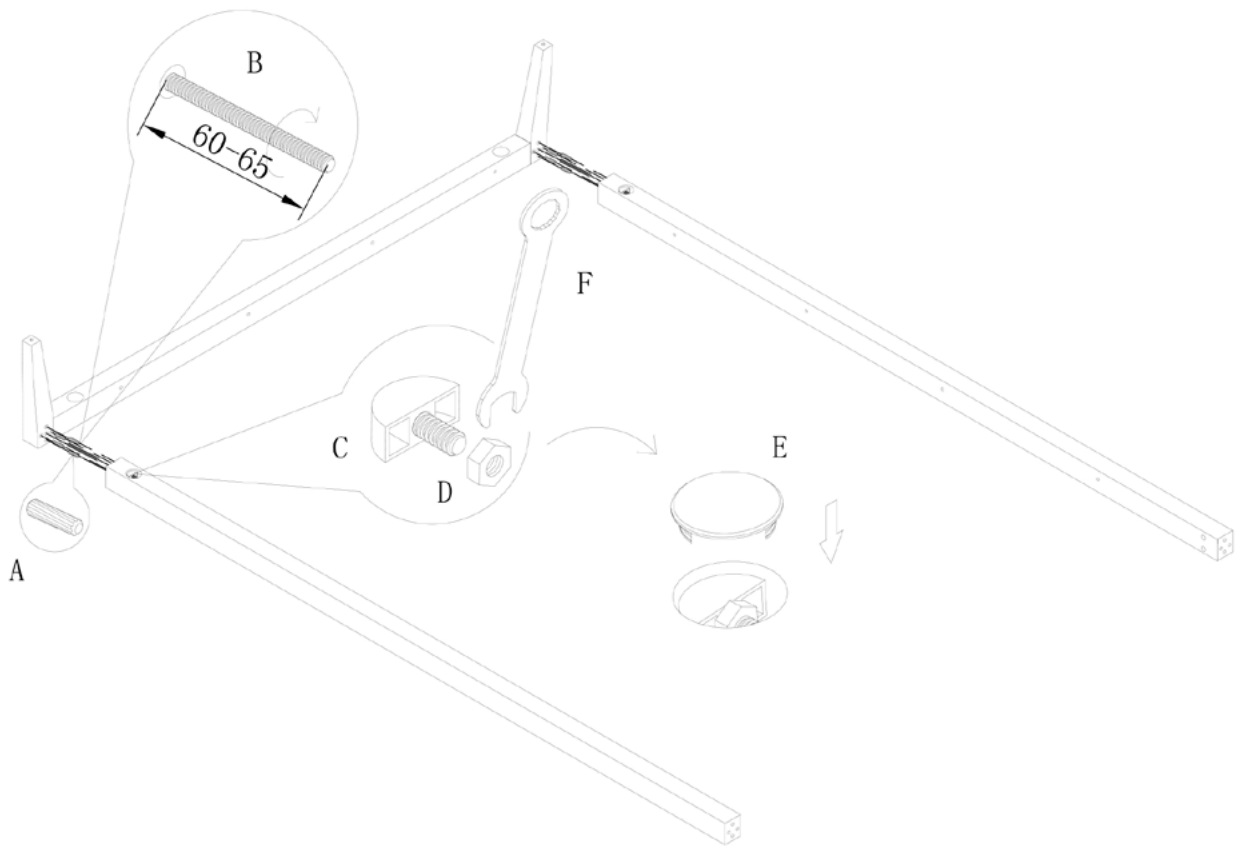

FIG.
1



**FIG.
2**



**FIG.
3**

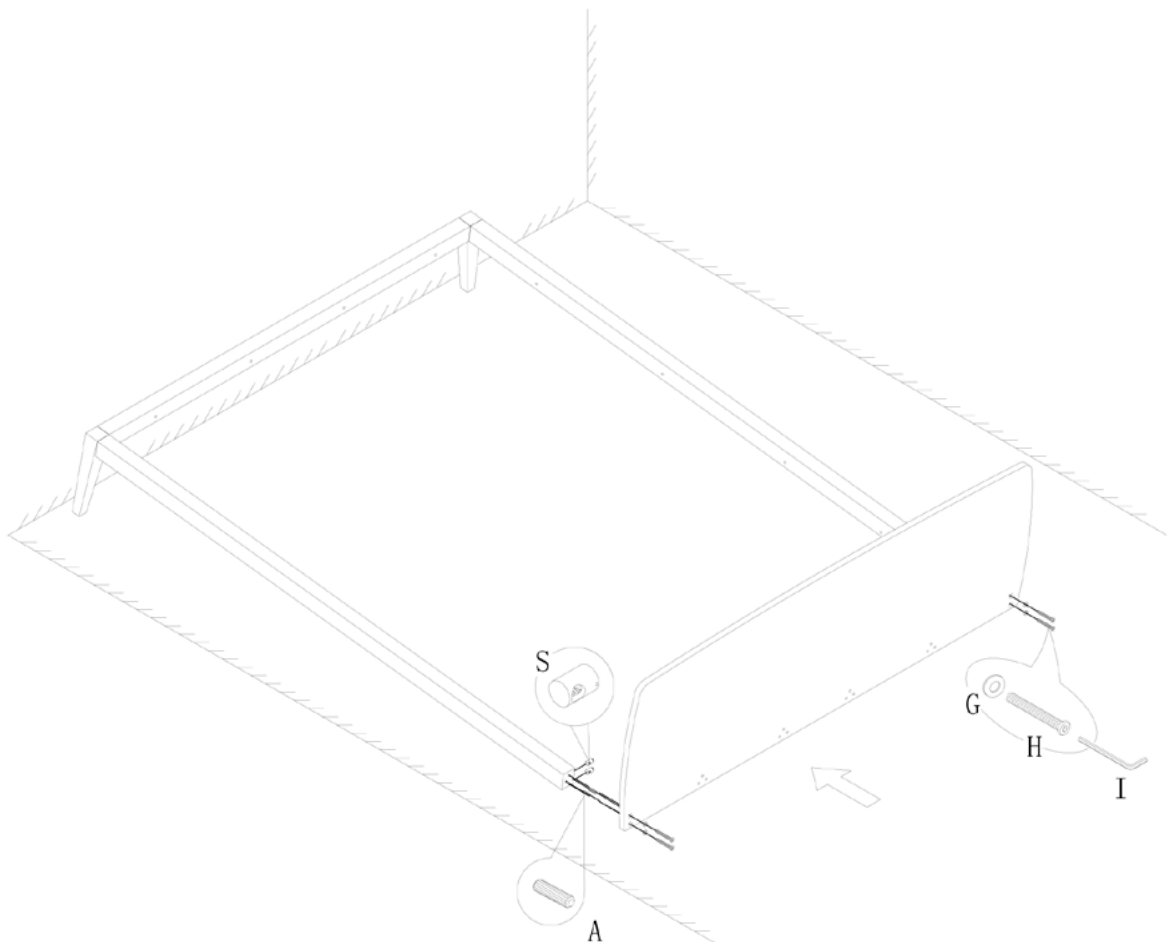

**FIG.
4**

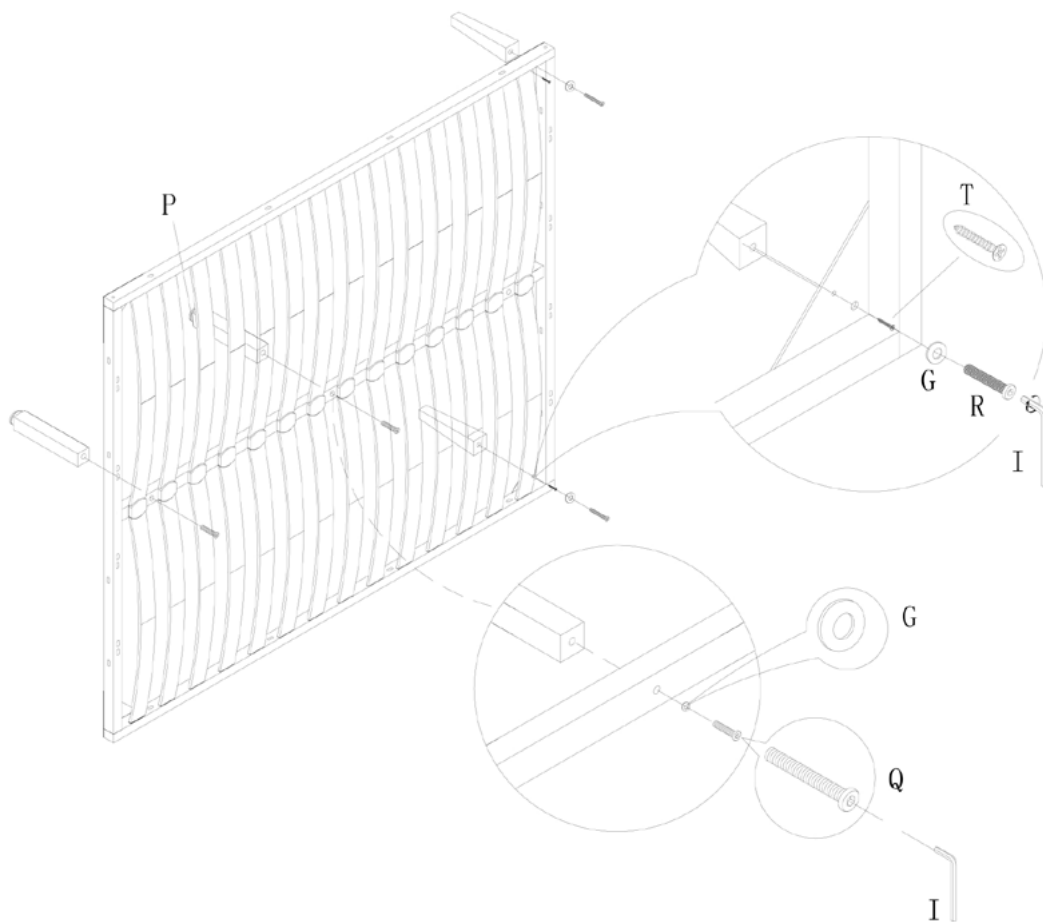

**FIG.
5**

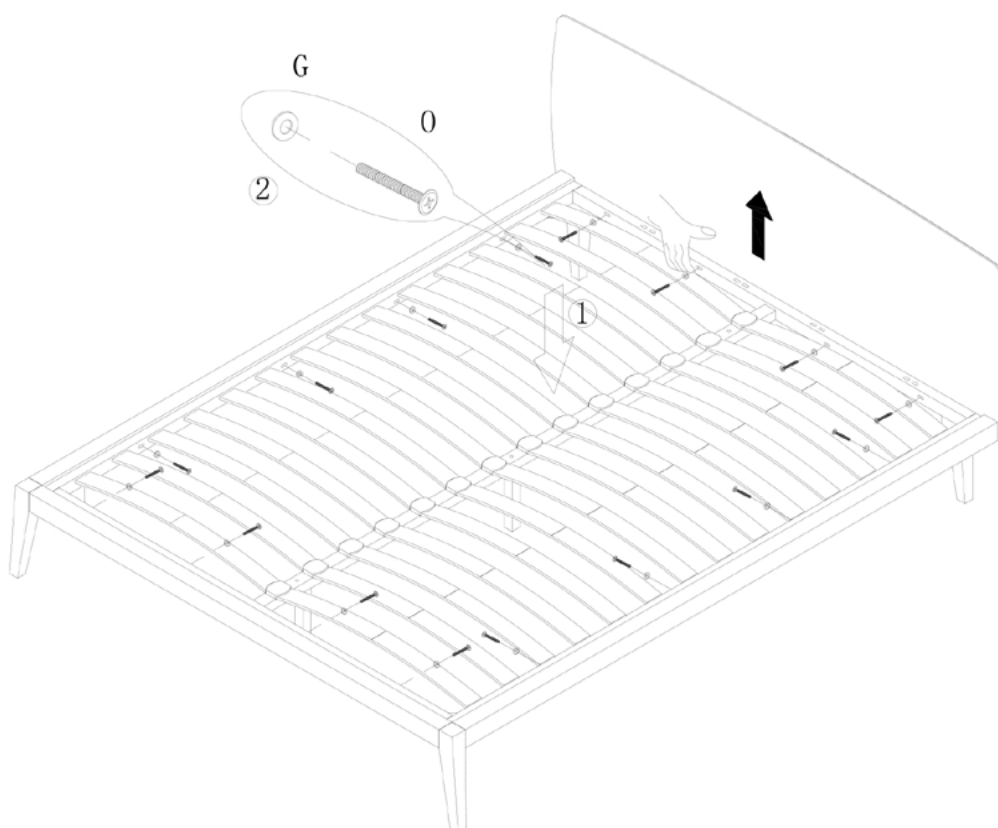

FIG.
6

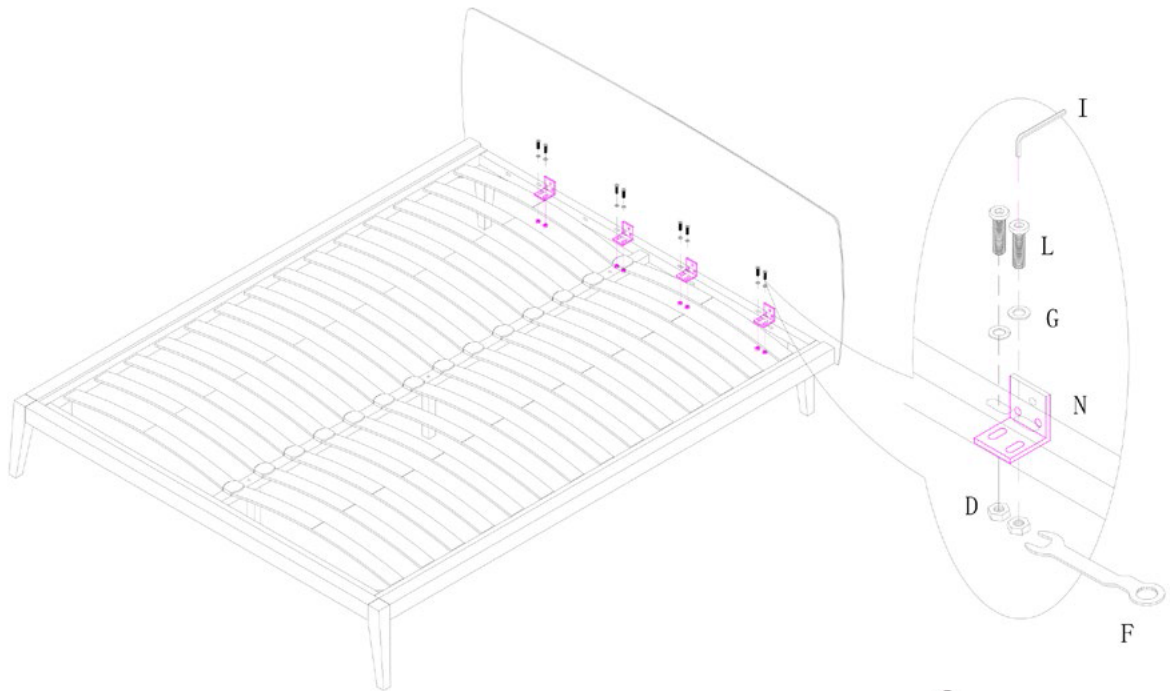

FIG.
7

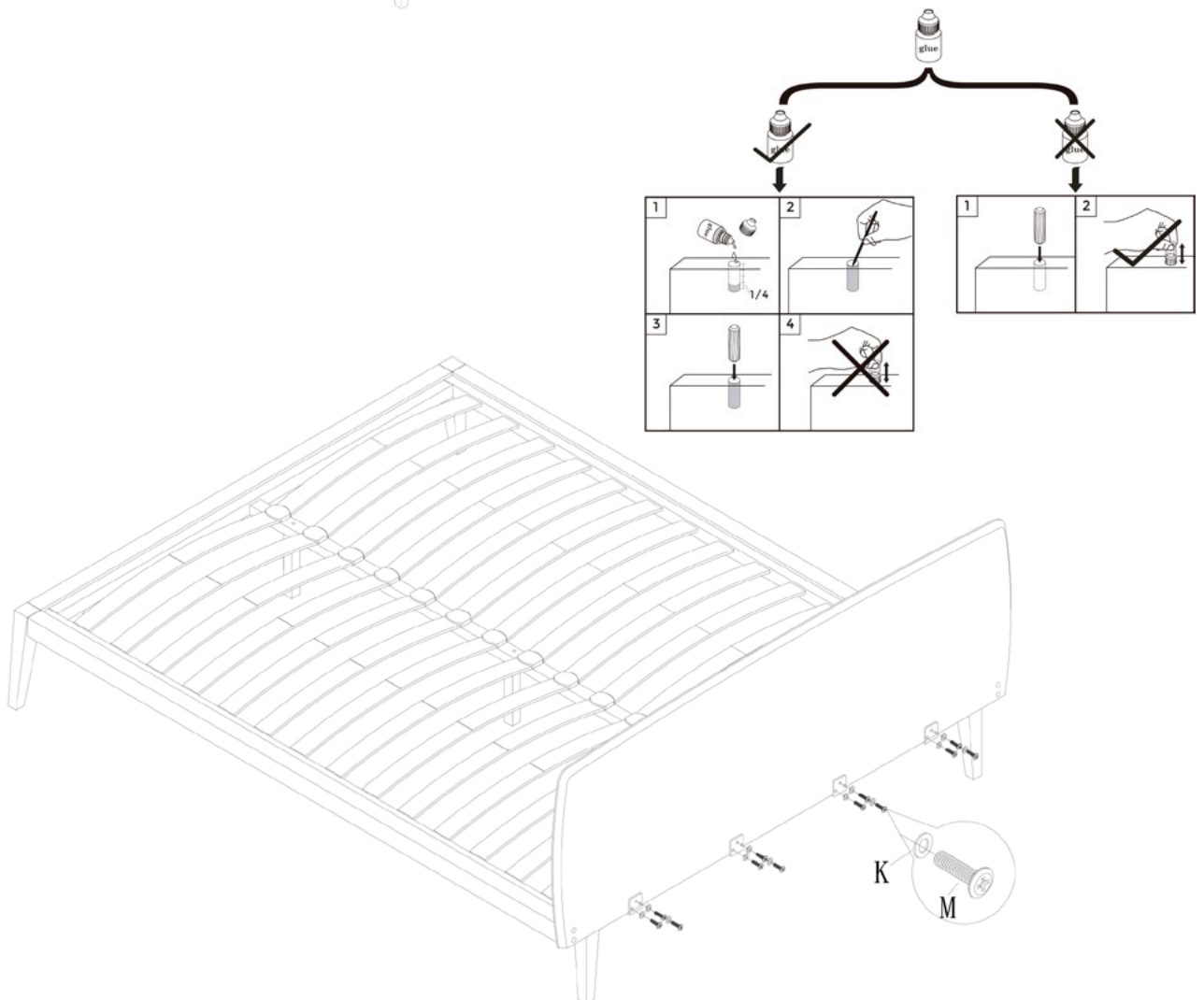

FIG.
8

